



## Description

Blade is designed for sustained, long-term performance with advanced thermal management, an elegantly simple heat sink and industry leading surge protection. This economical product line provides value-oriented area lighting solutions for a variety of applications without compromising quality or performance. The LFST10 Wagonway Pathfinder is an aesthetically pleasing and functional dark sky compliant bollard which integrates functionally with visual comfort to match. Featuring 2 sizes to scale your project, this IP66 rated bollard is built to last and guide people safely into and out of your spaces. The optional side shield is used to direct light away from neighbors.

## Key Features

- IP66 and IK10
- Unique and gorgeous appearance
- Visor is available as accessory
- Professional Type V light distribution

## Applications

- Gardens
- Pathways
- Sidewalk
- Building entrance

## Electrical Information

Model No.	BL05-14	BL05-24
Power Consumption (±10%)	14W	24W
Power Supply	Weledpower	
Input Voltage	120-277 VAC , 50 / 60 Hz	
Power Factor	>0.9	
Surge Protection	2kV line-line, 2kV line-earth	
Driver Type	Constant Current (CC)	
Control	0-10V dimmable	
Note	NA	

## Optic Information

LED Type	LED 3030	
Luminous Flux (±10%)	1680lm	2520lm
Efficacy(4000K Ra70)	120lm/W(R03203)	105lm/W(R03203)
Correlated Color Temperature	4000K (3000K, 5000K optional)	
Color Rendering Index	Ra70 (Ra80 optional)	
Beam Angle	R03203 (Type V)	
UGR level	NA	

## Dimensions and Mount

Product Dimension	19.69 inch: Φ165×500mm (Φ6.5"×19.69") 42 inch: Φ165×1067mm (Φ6.5"×42")
Luminaire Net Weight (±0.3kg/±0.66Lbs)	19.69 inch: 4.5kg (9.92Lbs) 42 inch: 6.83kg (15.06Lbs)
Export Carton Size (All-in-one package)	Lamp 19.69 inch: 655x210x215mm(25.79"×8.27"×8.46") Lamp 42 inch: 1230x210x215mm(48.43"×8.27"×8.46")
Gross Weight (All-in-one package) (±0.3kg/±0.66Lbs)	Lamp 19.69 inch: 5.2kg (11.46Lbs) Lamp 42 inch: 7.87kg (17.35Lbs)
Export Carton Size (Separated package)	Lamp body: 360 x 210 x215mm(14.17"×8.27"×8.46") Lamp holder 19.69 inch: 505x210x215mm(19.88"×8.27"×8.46") Lamp holder 42 inch: 1075x210x215mm(42.32"×8.27"×8.46")
Gross Weight (Separated package) (±0.3kg/±0.66Lbs)	Lamp body: 2.66kg (5.86Lbs) Lamp holder 19.69 inch: 2.94kg (6.48Lbs) Lamp holder 42 inch: 5.44kg (11.99Lbs)
Mounting Option	Mounting kit with anchor bolts
Material	Aluminum alloy Polycarbonate optical Lens
Finish	Powder coating
Fixture Color	Black (RAL 9017)
EPA	NA
IK Rating	IK10
IP Rating	IP66
Category of corrosion	C3

## Lifespan and Warranty

Operating Temperature	-30°C to + 50°C(-22°F to 122°F)
Life Time of LED @Ta=25°C	37,800hrs-L90
	78,500hrs-L80
	124,600hrs-L70
Warranty	5 Years

## New Features

- 10KV SPD available

\* Please consult us for details.

## Photometry

14W beam angle

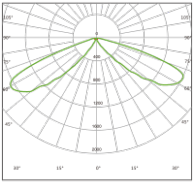

A03203

24W beam angle

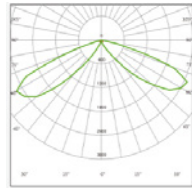

A03203

## Mounting Options

Mounting kit with anchor bolts

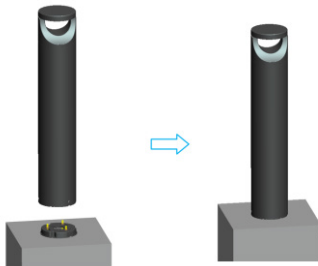

## Dimensions

19.69 inch 14W/24W

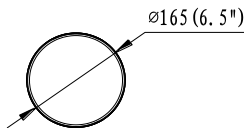

42 inch 14W/24W

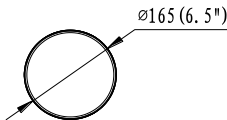
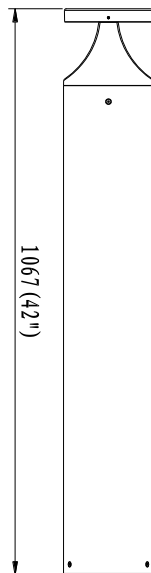

Base plate templates

Unit:mm/inch

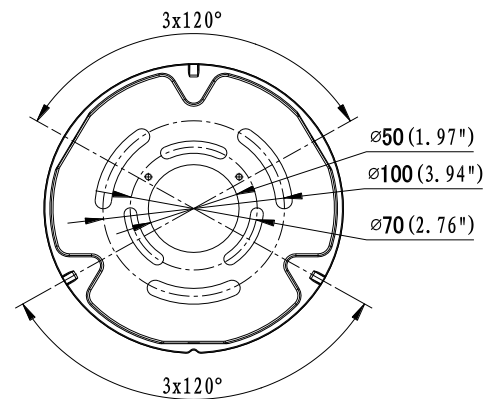

## Accessories



**Round House Side Shield**  
To reduce glare light



**Terminal Box**



**Backfilled Anchor**  
Q235 +SPCC, hot dip galvanizing  
Φ130x508mm.